

Formulate Accent - 02

FMLT-WL02

Formulate™ accents enhance the functionality of any 10ft or 20ft backwall and add more real estate for messaging too! With monitor supports, literature pockets, shelves, tables, counters and more, you are sure to find the accent that best suits your needs. Side tables and graphic headers also available.

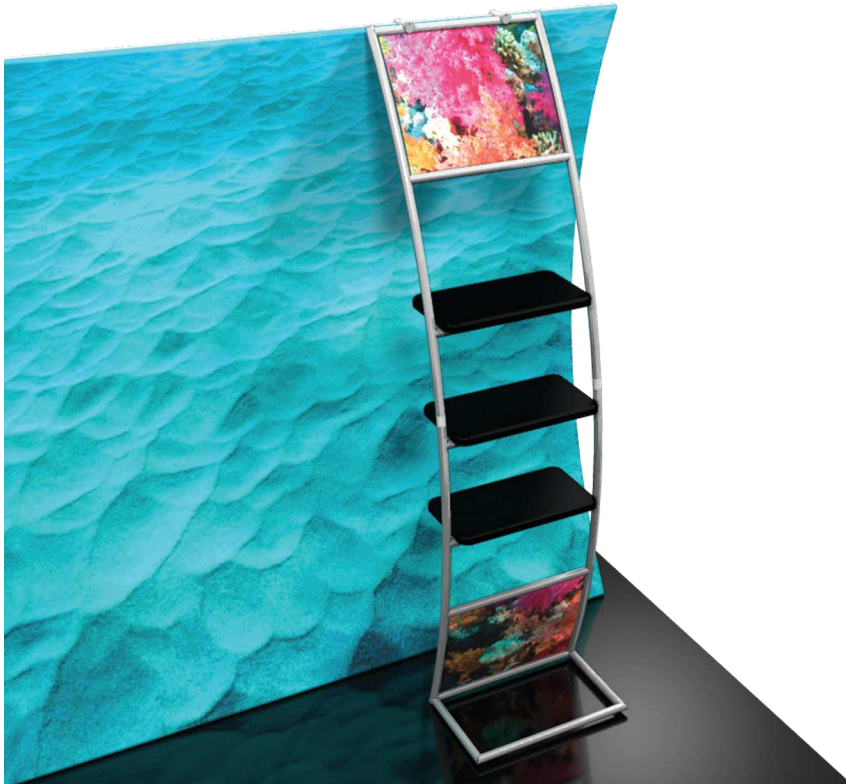

features and benefits:

- State-of-the-art brushed 30mm aluminum tube frame with snap button assembly
- Includes three 20" wide shelves available in four laminate color options
- Easy to store and ship
- Kit includes: one frame, two printed infill panel graphics, stand-off shelves, and one wheeled molded OCH2 storage case
- Lifetime hardware warranty against manufacturer defects

dimensions:

| Hardware | Graphic |
|--|--|
| <p>Assembled unit: 23.6"w x 92.7"h x 26.6"d 668mm(w) x 2355mm(h) x 676mm(d)</p> <p>Shelf dimensions (each): 20.47"w x 11.81"d</p> <p>Approximate weight (includes graphics): 24 lbs / 10.88 kg</p> | <p>Total visual area: Top & bottom: 21"w x 17.5"h</p> <p>Please be sure to include the 1/2" bleed around the perimeter.</p> <p>Refer to related graphic template for more information.</p> |
| Shipping | |
| <p>Shipping dimensions: 1 OCH2 case: 52"l x 30"w x 15"h</p> <p>Approximate shipping weight (with case): 54 lbs / 24.5 kg</p> | |

additional information:

Graphic material:
3mm white pvc

Shelves holds max 10 lbs /4.5 kg each

Table colors:



silver black mahogany natural

We are continually improving and modifying our product range and reserve the right to vary the specifications without prior notice. All dimensions and weights quoted are approximate and we accept no responsibility for variance. E&OE. See Graphic Templates for graphic bleed specifications.

Parts Included – Ladder

| Part Label | Qty | Part Code |
|---------------------------------------|---------|-----------|
| 520 X 300 X 30 COUNTER | x3 | CTWL |
| SILVER ANODIZE FINISH 30MM TUBE CLAMP | x2 | TC-30 |
| 30MM TUBE SECTION | x2 | WL-T3 |
| TOP SINTRA GRAPHICS | x2 | WLLH-T-G |
| 30MM TUBE SECTION | x1 | WL-T5 |
| 30MM TUBE SECTION | x1 | WL-T6 |
| 30MM TUBE SECTION | x1 </tr | |

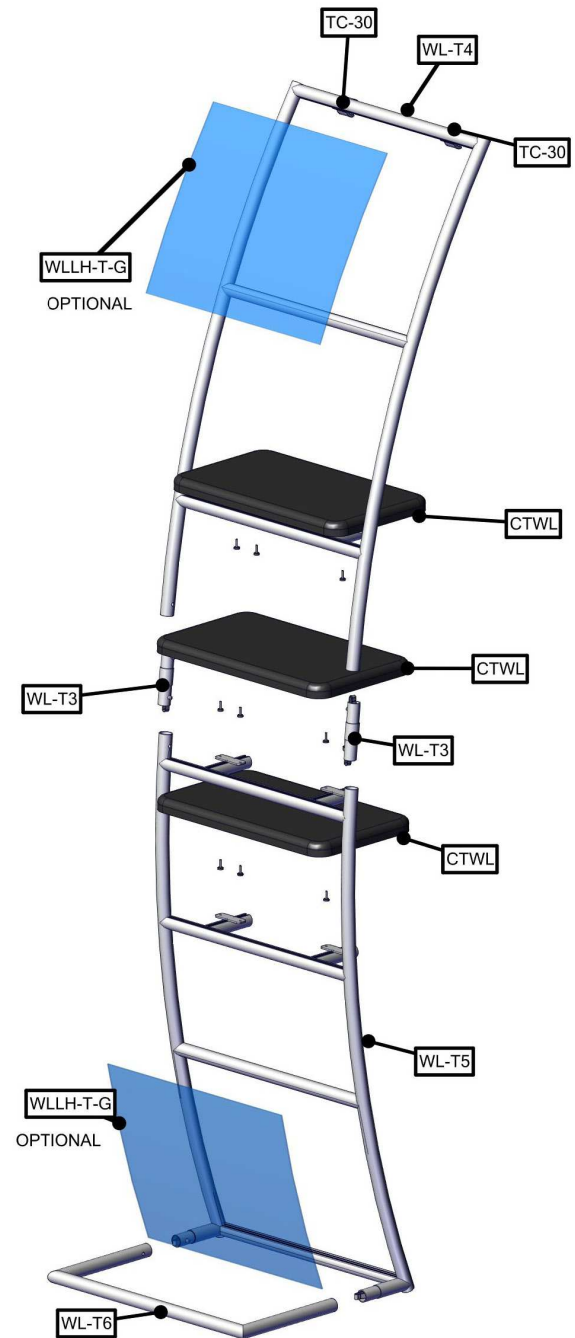
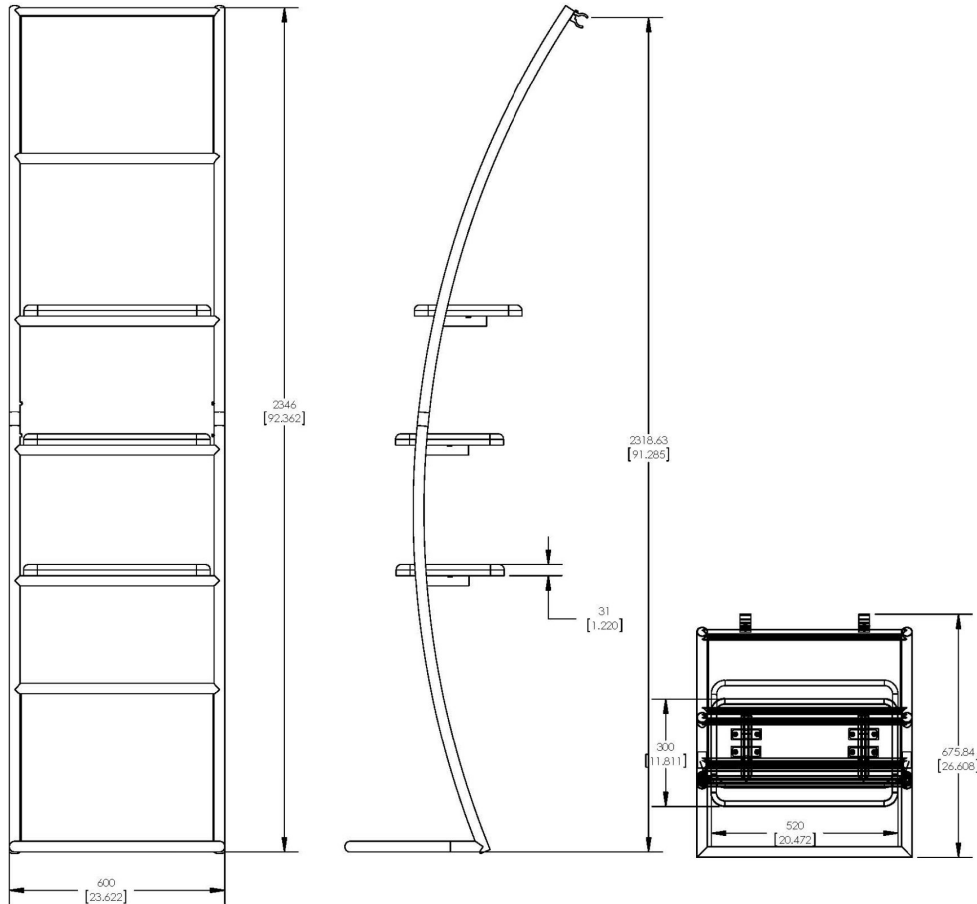

STEP 1: ASSEMBLE LADDER FRAME

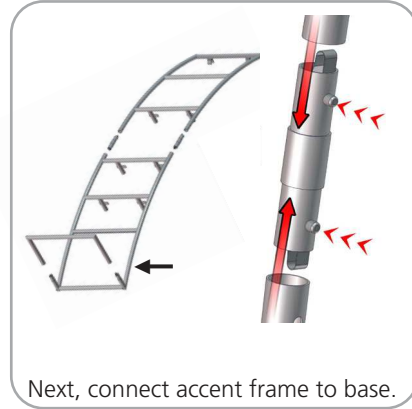
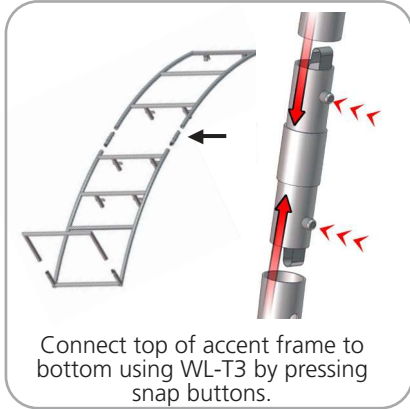

STEP 2: ATTACH SHELVES

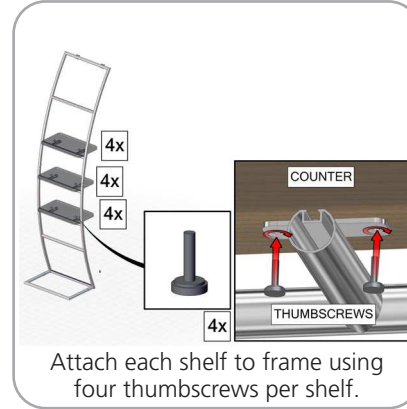

STEP 3: ATTACH GRAPHICS

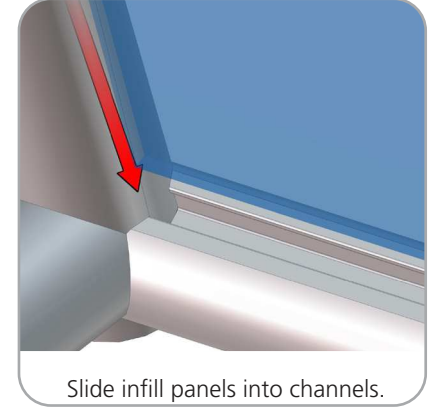

STEP 4: ATTACH TO BACKWALL WITH CLAMPS

