

# Formulate 8' Four Sided Tower

## COL-03

Mix and match the Formulate® line of towers to add architecture and drama to any event or interior space. Rectangular-shaped towers come in 12ft, 10ft and 8ft heights and 3ft square at the top and bottom. They combine the latest developments in fabric printed technology with aluminum tube frames to add dimension, decor and sculpture to any event, stage set, tradeshow booth or interior space. Formulate towers accommodate internal LED lighting to create a glowing effect.



## features and benefits:

- State-of-the-art 30mm aluminum tube frame with snap button assembly
- Easy to store and ship
- Quick to set up
- Kit includes: one frame, one dye-sublimated zipper pillowcase graphic, and one wheeled storage case
- Lifetime hardware warranty against manufacturer defects

## dimensions:

### Hardware

### Graphic

Assembled unit:  
36" w x 96" h x 36" d  
915mm(w) x 2439mm(h) x 915mm(d)

Refer to related graphic template for more information.

Approximate weight (includes graphic):  
24 lbs / 11 kg

Visit:  
<https://www.theexhibitorshandbook.com/download-graphic-templates>

### Shipping

## additional information:

Packing case(s):  
1 OCL

Graphic material:  
Dye-sublimation zipper pillowcase fabric

Shipping dimensions:  
OCL:  
57" l x 19" h x 19" d  
1448mm(l) x 483mm(h) x 483mm(d)

Approximate total shipping weight:  
44 lbs / 20 kg

We are continually improving and modifying our product range and reserve the right to vary the specifications without prior notice. All dimensions and weights quoted are approximate and we accept no responsibility for variance. E&OE. See Graphic Templates for graphic bleed specifications.

# Included In Your Kit

Tools, Components, & Connectors



TC-30-3W x8

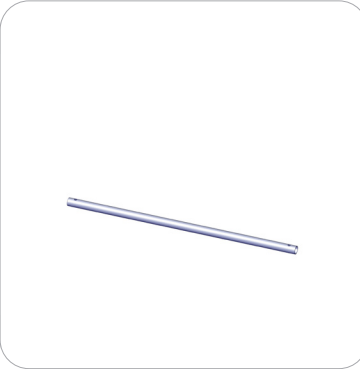

COL-01-T1 x8

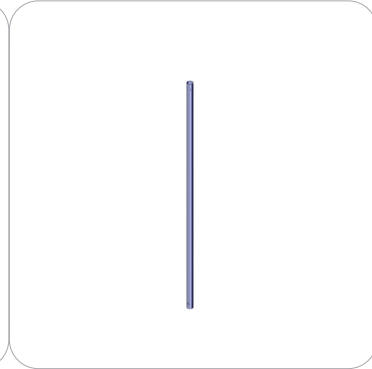

COL-01-T2 x8

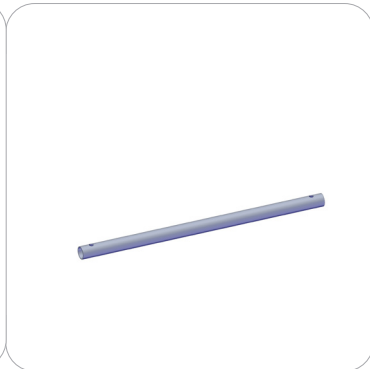

COL-01-T3 x4

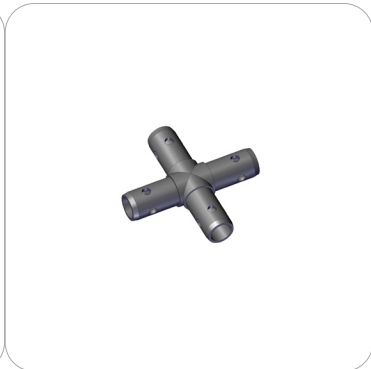

TC-30-X x1



TC-30-T x4

Graphics

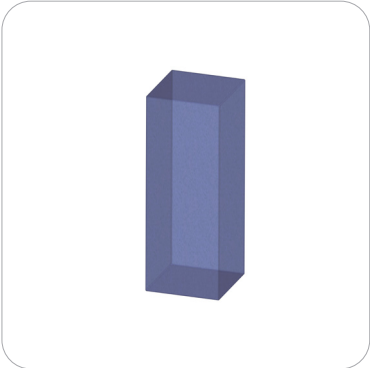

COL-03-G x1

# Exploded View

COL-03

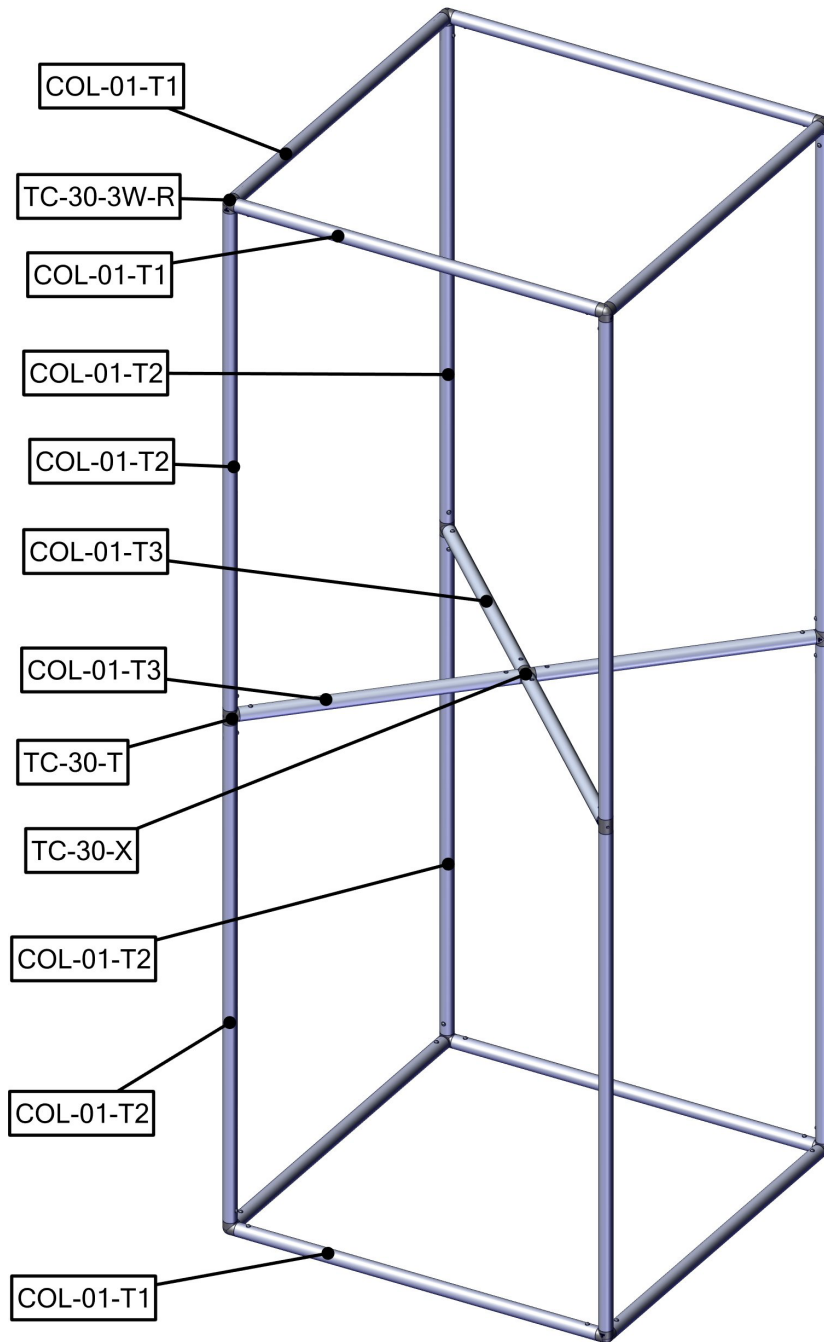

# Labeling Diagram

COL-03

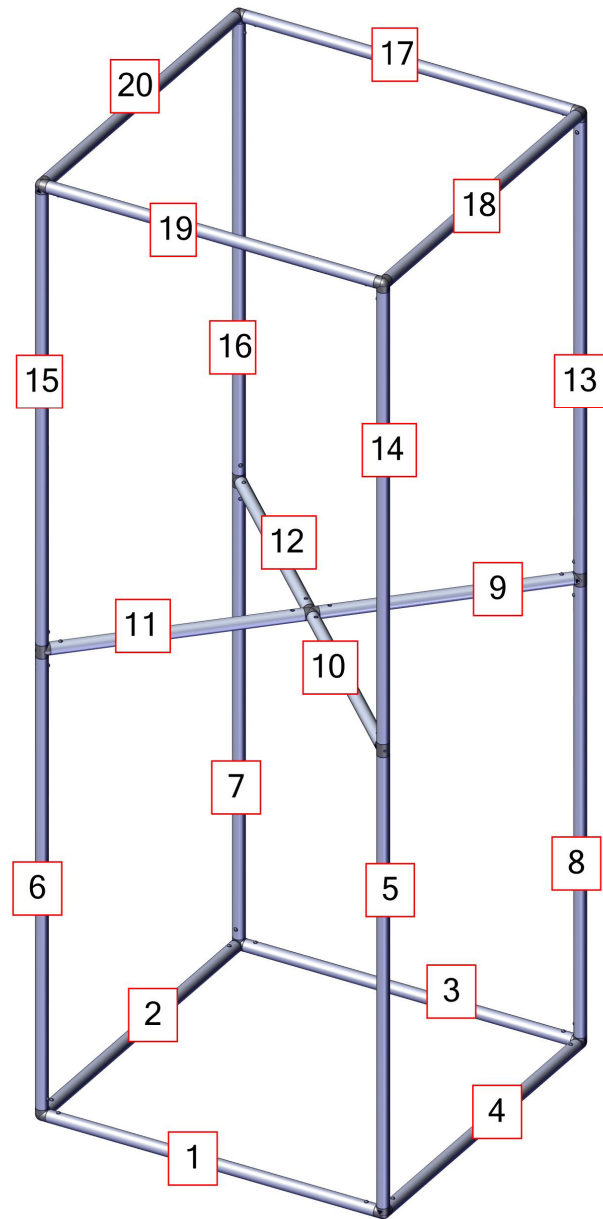

# Kit Assembly

## Step by Step

### Step 1.

Gather the components to build Section 1 of the tower frame. Use the Exploded View and the Labeling Diagram for part labels.

Reference Connection Methods 1 for more details.

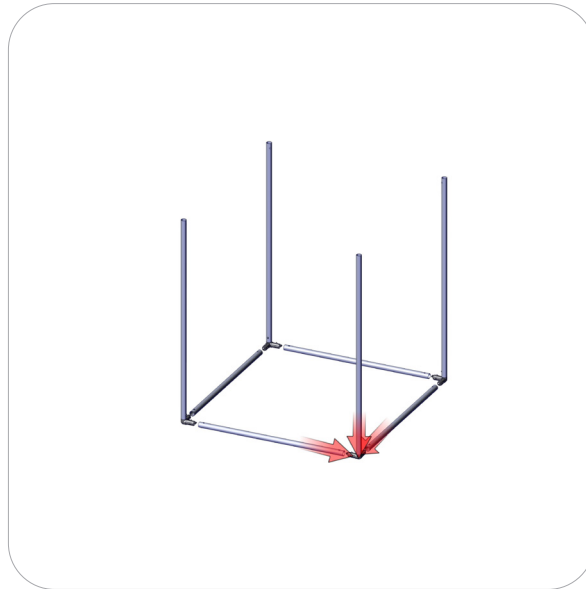

### Step 2.

Gather the components to build Section 2 of the tower frame. Use the Exploded View and the Labeling Diagram for part labels.

Reference Connection Method 2 for more details.

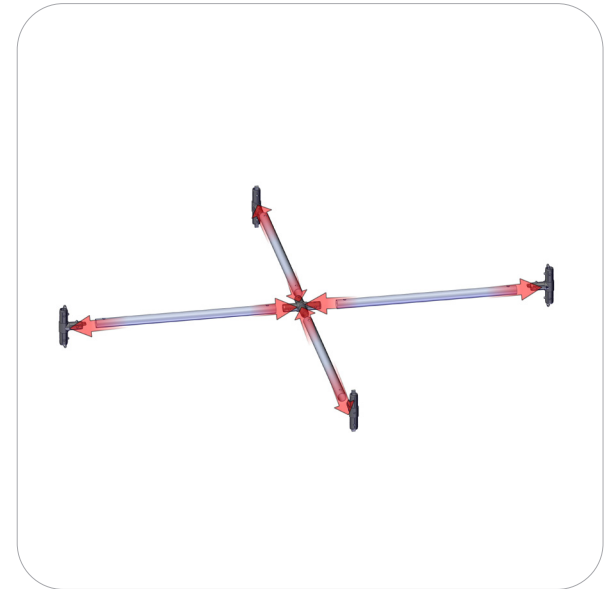

### Step 3.

Gather the components to build Section 3 of the tower frame. Use the Exploded View and the Labeling Diagram for part labels.

Reference Connection Methods 1 for more details.



### Step 4.

Lay the three sections flat on floor. Combine them to complete the tower frame assembly. Use the Exploded View and the Labeling Diagram for part labels.

Reference Connection Method 3 for more details.

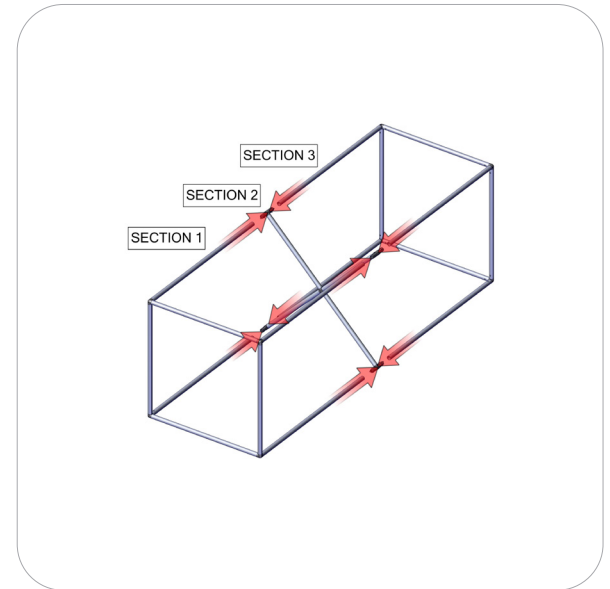
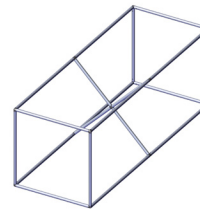

# Kit Assembly

## Step by Step

### Step 5.

Leave the tower frame flat on floor. Undo the zipper pillow case and pull it over the top of the tower. Work the pillowcase down to the bottom of the frame carefully zip it up and then stand the frame upright.

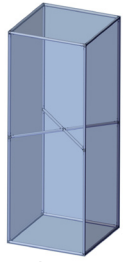

**Setup Complete**

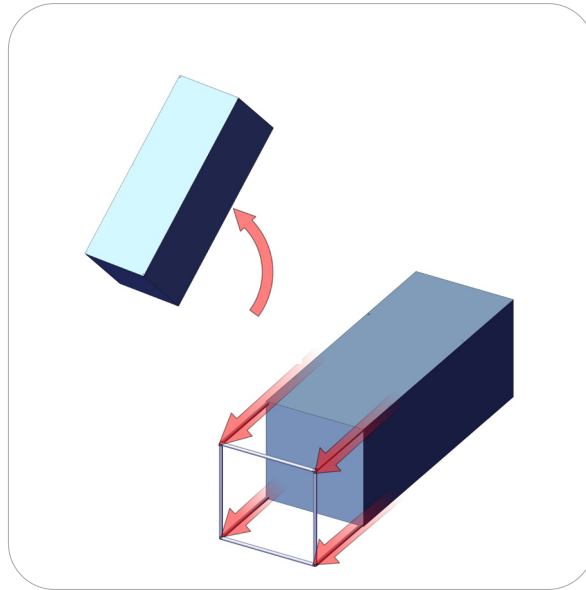

# Connection Methods

## Connection Method 1: COL-T1/ COL-T2/ TC-30-3W

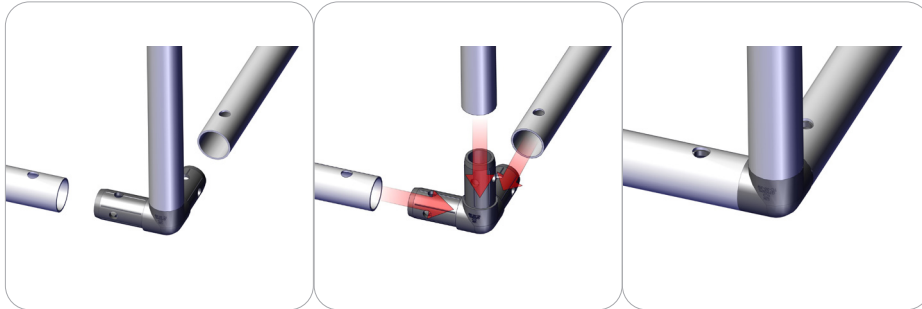

First, Connect bottom tubes (COL-T1) and side tubes (COL-T2) to TC-30-3W. Repeat previous step until all four sides of bottom are assembled. Use this method for the TOP & BOTTOM.

## Connection Method 2: TC-30-X

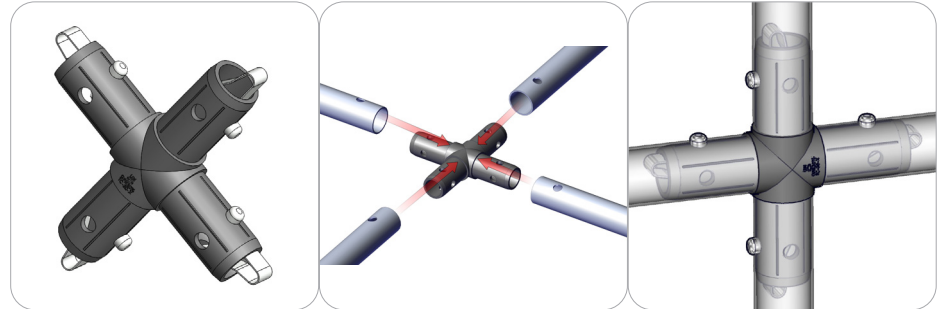

First, connect spreader tubes (COL-T3) to TC-30-X. Second, once the X frame is assembled, connect side tubes (COL-T6).

## Connection Method 3: COL-T2/ TC-30-T/ COL-T3

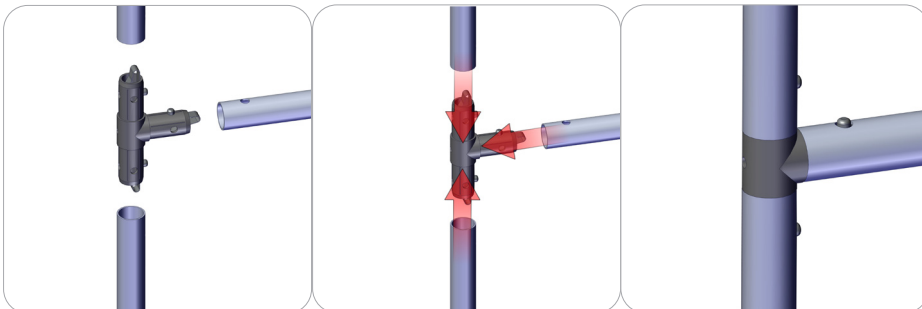

Slide the COL-T3 into the TC-30-T until it snaps in place. Repeat this for all 4 middle sections. Follow same process with connecting COL-T2 to TC-30-T.