

MODCO 11 - 20 x 10



MODCO 11 - 20 x 10

- Use REF column to reference parts. Reference "Birds eye view" for footprint orientation.

Part 1 of 3

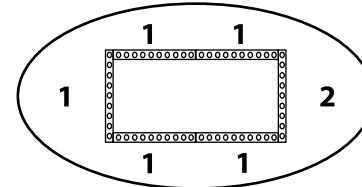
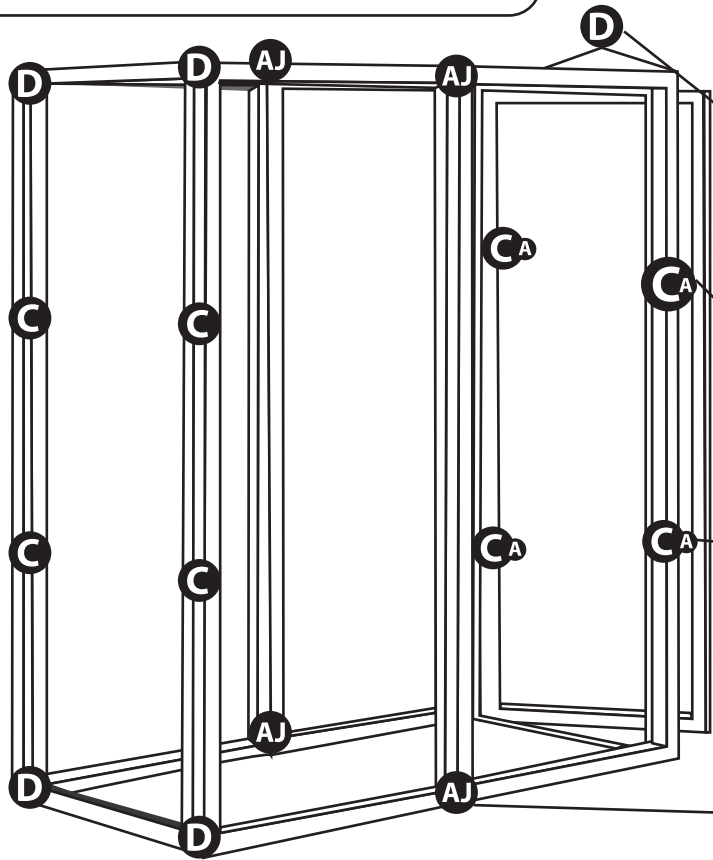

Birds eye view

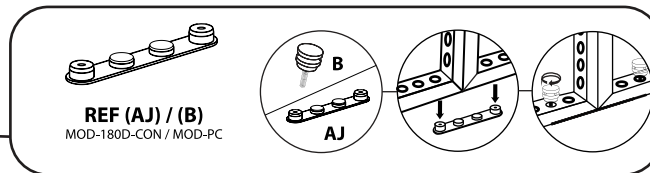
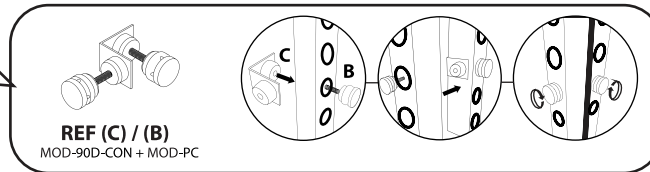
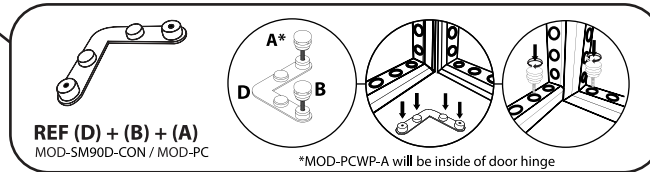

PARTS LIST (TOWER)

REF	QTY	PART NO.	DESCRIPTION
1	11	MOD-FRM-992x2418	Straight Frame, Corner Screw Connect 992mm x 2418mm
2	1	MOD-DSWL-992x2418	Door Set w/ Lock 992mm x 2418mm
A	4	MOD-PCWP-A	Pin Connector for Door Jamb
B	48	MOD-PC	Pin Connector
C	16	MOD-90D-CON	90° Connector
D	6	MOD-SM90D-CON	90° Connector
E	18	MOD-CLA-CON	Clamp Connector
AJ	4	MOD-180D-CON	180 Degree Connector
AA	2	MOD-DCC-180D	Door Clamp Connector, 180 Degrees (Connect to Wall Frame)

MODCO 11 - 20 x 10

- Use REF column to reference parts. Reference "Birds eye view" for footprint orientation.
Part 2 of 3

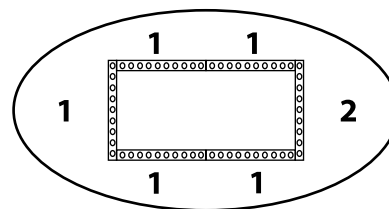
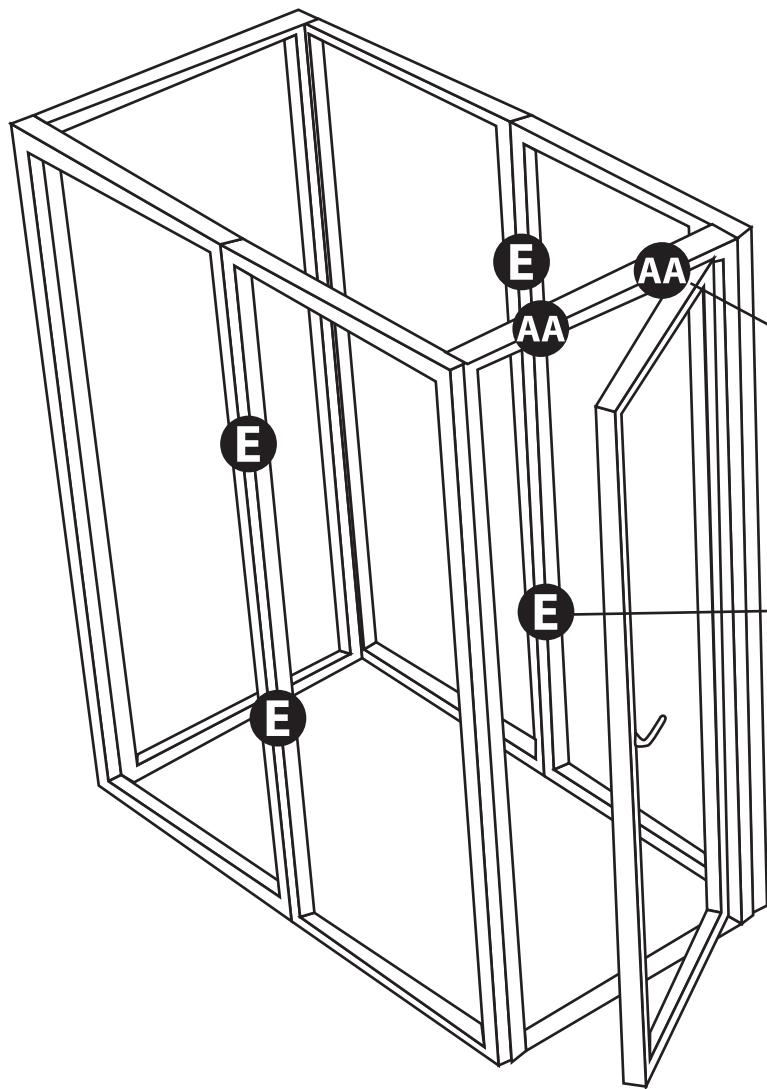

Birds eye view

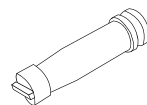

REF (AA)
MOD-DCC-180D

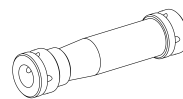
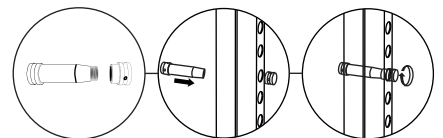

REF (E)
MOD-CLA-CON

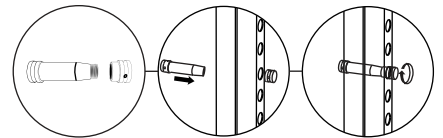

MODCO 11 - 20 x 10

- Use REF column to reference parts. Reference "Birds eye view" for footprint orientation.
Part 3 of 3 - Second floor of tower.

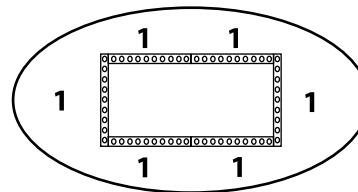
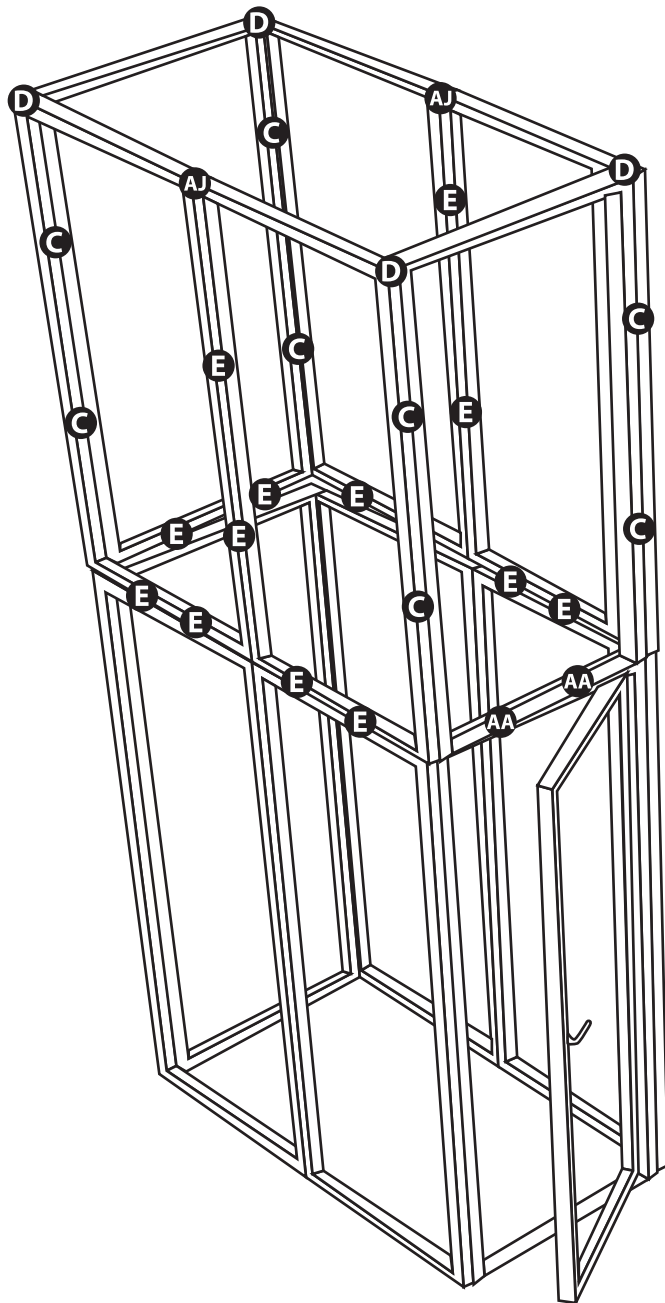

Birds eye view

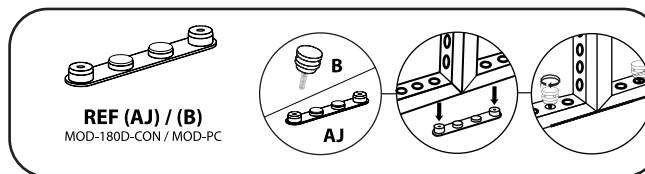
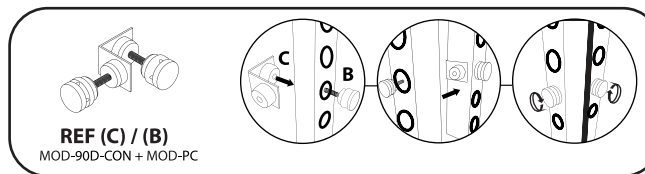
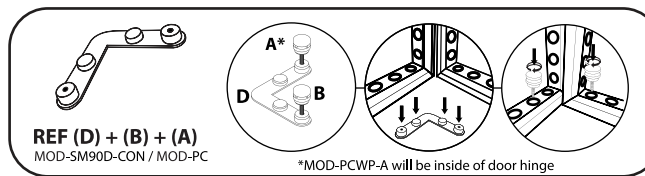

MODCO 11 - 20 x 10

- Use REF column to reference parts. Reference "Birds eye view" for footprint orientation.
Part 1 of 3 - Bridge (3 frames)

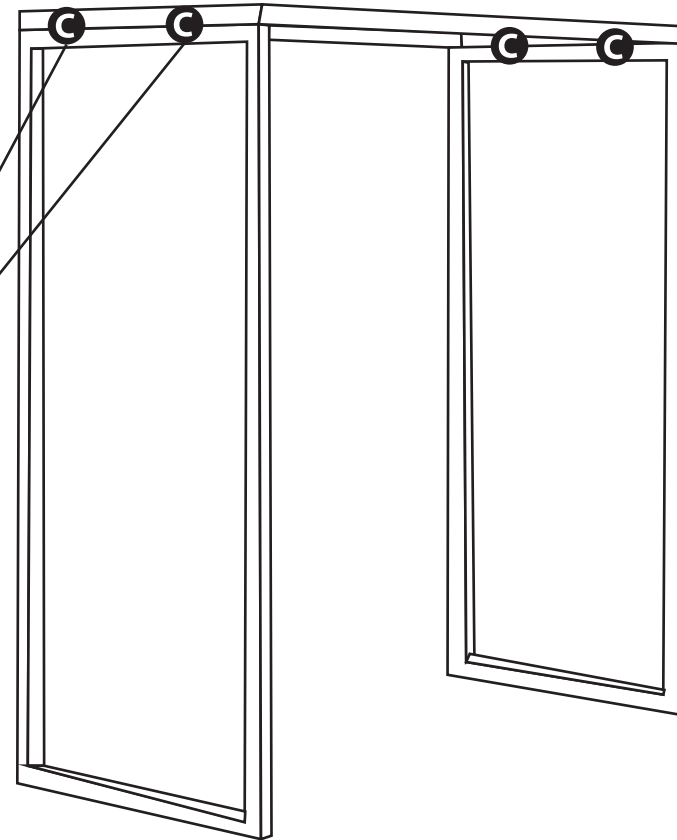
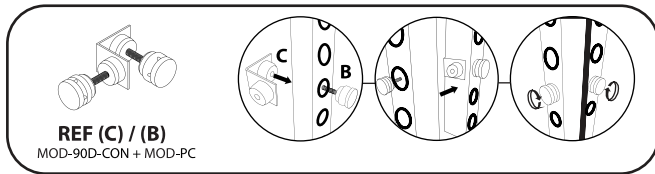
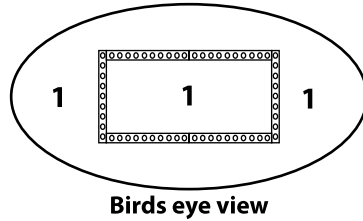

PARTS LIST (BRIDGE & COUNTERS)

REF	QTY	PART NO.	DESCRIPTION
1	2	MOD-FRM-992x2418	Straight Frame, Corner Screw Connect 992mm x 2418mm
11	2	MOD-FRM-992x2480	Straight Frame, Corner Screw Connect 992mm x 2480mm
5	4	MOD-FRM-992x992	Straight Frame, Corner Screw Connect 992mm x 992mm
6	4	MOD-FRM-310x992	Straight Frame, Corner Screw Connect 310mm x 992mm
B	44	MOD-PC	Pin Connector
C	2	MOD-90D-CON	90° Connector
D	20	MOD-SM90D-CON	90° Connector
E	2	MOD-CLA-CON	Clamp Connector

MODCO 11 - 20 x 10

- Use REF column to reference parts. Reference "Birds eye view" for footprint orientation.
Part 2 of 3 - Bridge and Tower

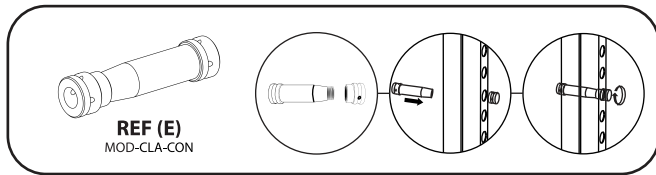
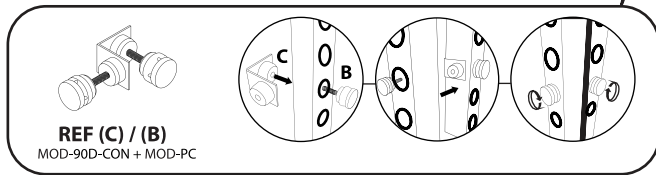
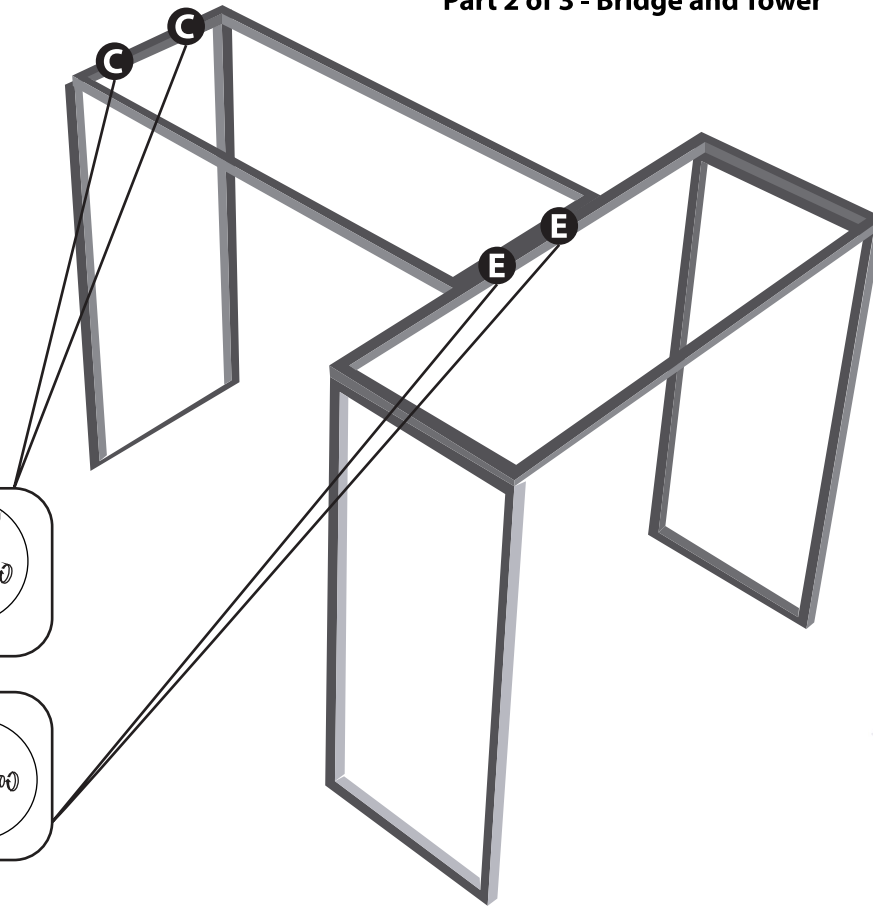

PARTS LIST (BRIDGE & COUNTERS)

REF	QTY	PART NO.	DESCRIPTION
1	2	MOD-FRM-992x2418	Straight Frame, Corner Screw Connect 992mm x 2418mm
11	2	MOD-FRM-992x2480	Straight Frame, Corner Screw Connect 992mm x 2480mm
5	4	MOD-FRM-992x992	Straight Frame, Corner Screw Connect 992mm x 992mm
6	4	MOD-FRM-310x992	Straight Frame, Corner Screw Connect 310mm x 992mm
B	44	MOD-PC	Pin Connector
C	2	MOD-90D-CON	90° Connector
D	20	MOD-SM90D-CON	90° Connector
E	2	MOD-CLA-CON	Clamp Connector

MODCO 11 - 20 x 10

- Use REF column to reference parts. Reference "Birds eye view" for footprint orientation.
Part 3 of 3 - Counters

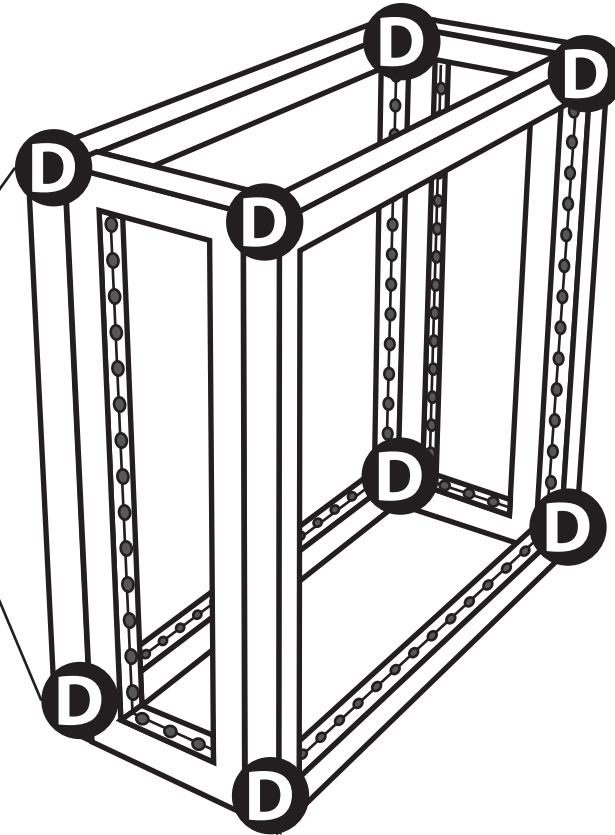
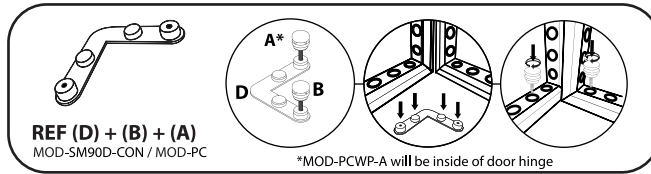

PARTS LIST (BRIDGE & COUNTERS)

REF	QTY	PART NO.	DESCRIPTION
1	2	MOD-FRM-992x2418	Straight Frame, Corner Screw Connect 992mm x 2418mm
11	2	MOD-FRM-992x2480	Straight Frame, Corner Screw Connect 992mm x 2480mm
5	4	MOD-FRM-992x992	Straight Frame, Corner Screw Connect 992mm x 992mm
6	4	MOD-FRM-310x992	Straight Frame, Corner Screw Connect 310mm x 992mm
B	44	MOD-PC	Pin Connector
C	2	MOD-90D-CON	90° Connector
D	20	MOD-SM90D-CON	90° Connector
E	2	MOD-CLA-CON	Clamp Connector

MODCO 11 - 20 x 10

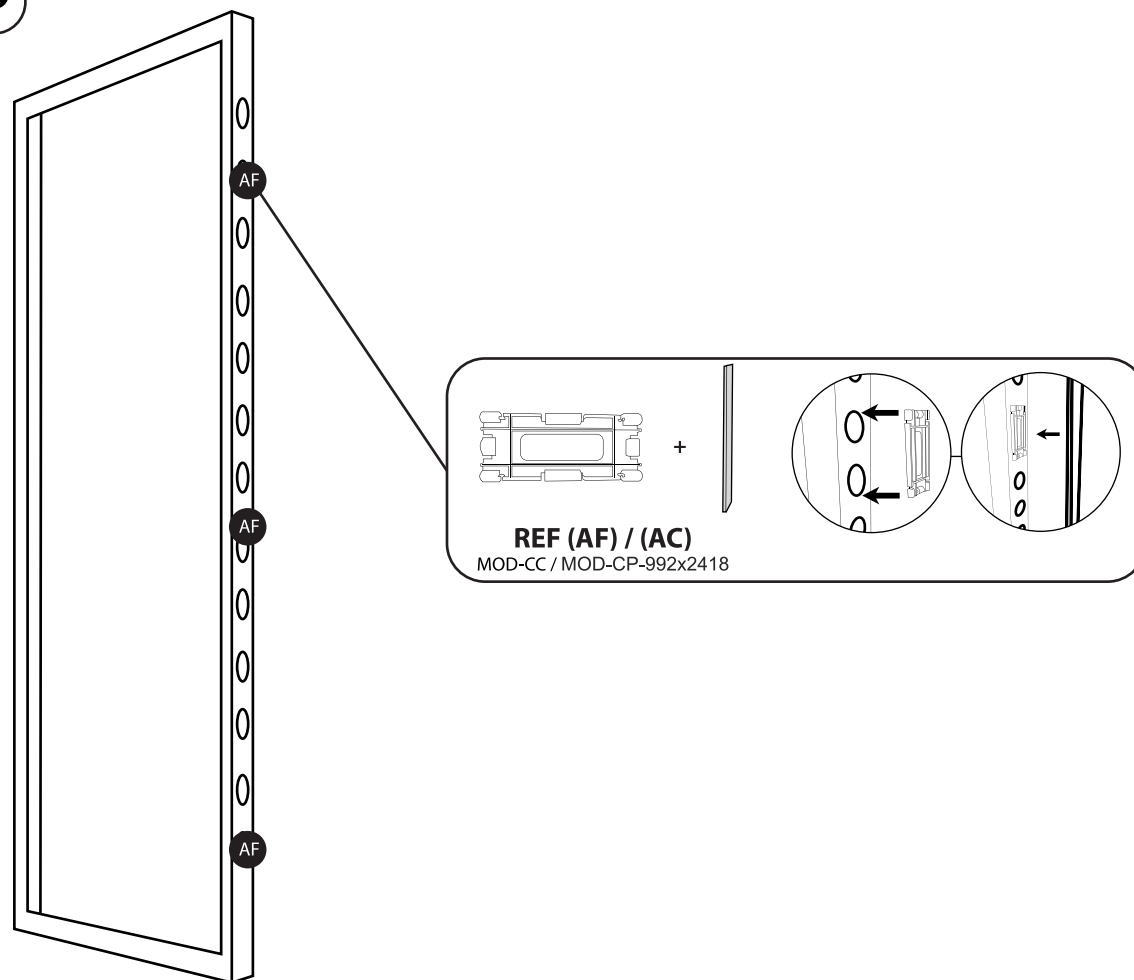

COVER PROFILES & ACCESSORIES

REF	QTY	PART NO.	DESCRIPTION
AC	12	MOD-CP-992x2418	Cover Profile for Frame 992x2418. Flat Model. Anodized
AD	3	MOD-CP-992x2480	Cover Profile for Frame 992x2480. Flat Model. Anodized
AE	3.68	MOD-CP-3100	Cover Profile, Bar Per 3100mm Cover Profile. Flat Model. Anodized
AF	69	MOD-CC	Clip Connector Cover Connects Cover Profile
AL	96	MOD-FP	Modco Frame Protector
	1	MX-CRATE-F	Wooden Crate of L 104",W 44",H 54" made in Mexico

GRAPHIC INSTALL

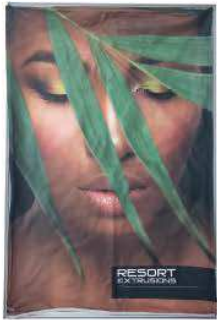

Place graphic over the front of the frame.



Begin inserting SEG beading at each corner.



YES

NO

Insert the silicone beading with the fabric folded over. The silicone beading should not be exposed.

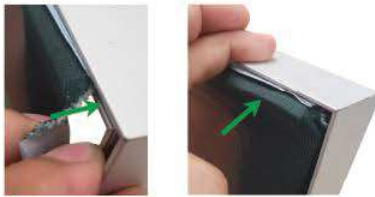

Using your fingers, push both fabric and silicone beading completely into the extrusions channel.



Continue to push in the remaining silicone beading on each side.



Check the perimeter of the frame for any excess beading that hasn't been pushed in. Graphic should be taut.